

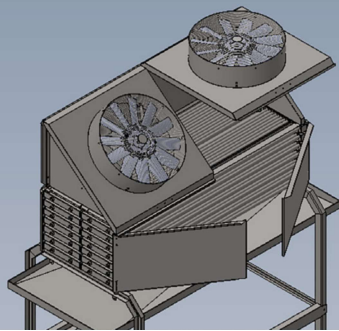

# ModulAir

## A SCALABLE AIR HANDLER THAT ADAPTS TO EVERY NEED

ModulAir units **regulate** the temperature and humidity of your processing areas. Available in either a **single or dual-flow design**, this unit can meet the needs for a wide range of room sizes. **Hygienic** design, constructed in stainless-steel, these are easy to clean units that are safe for both operators and products. These units also have a small footprint and can be installed on the wall, set on the **floor**, or hung from the **ceiling**. ModulAir units range from **2,500 to 20,000 m3/h**



## BENEFITS OF THE MODULAIR SERIES

- 1 Easy upgrades for future growth**
- Mass industrial production with quality control
  - Lego-type Assembly
  - Responsiveness : spare parts always stocked
  - Free-blowing or textile ducts
  - Double walled drain pan

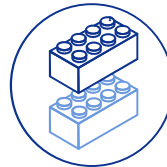

- 2 Hygienic design & construction**
- Constructed in 304L stainless steel
  - Hygienic design : eliminates all retention zones
  - Fully washable components (foam gun or CIP system)



- 3 A reliable, durable unit**
- Resistant to aggressive environments
  - Ability to upgrade an existing unit by adding additional coils
  - Potential to recondition existing equipment

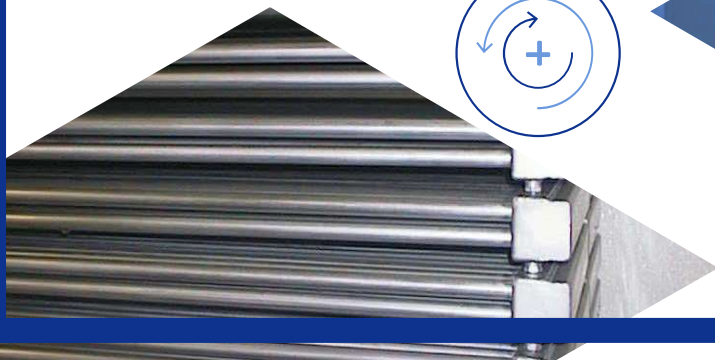
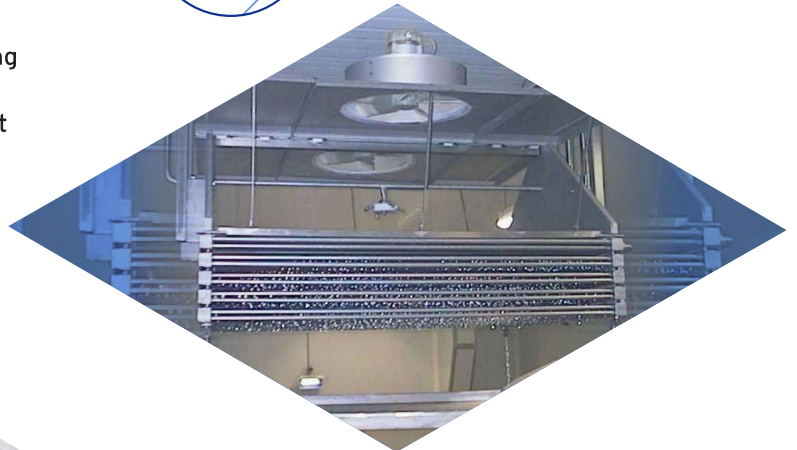



# ModulAir

## NOMENCLATURE

Nomenclature examples: *SF3PL- 4F-1C-2V3x380v*  
Options: *PRav, PXar, BH, SD*

### Models

- SF3:** Simple flow | 1 stack
- SF6:** Simple flow | 2 stacks
- DF3:** Dual-flow | 2 stacks
- DF4.5:** Dual-flow | 3 stacks
- DF6:** Dual-flow | 4 stacks

- PL:** Ceiling
- MU:** Wall
- CH:** Frame

### Cooling coil (DX, chilled water, glycol)

**n F:** number of chilled water coil rows (Ex: 4F)

### Heating coils (or heating element)

**n C:** number of hot water coil rows (Ex: 1C)

**p EL v:** electric heating power & supply voltage.

### Fans

**n V v:** number of axial fans & power supply  
(Ex: *Tri 400V*)

### Options

- PRav:** front access doors
- PXav:** hinged front panels
- PRar:** rear access doors
- PXar:** rear hinged panels
- BH:** humidification nozzle
- RL:** cleaning ramp
- SD:** direct air discharge
- SG:** air discharge via textile ducts

**DF4.5CH-9F-3C-6V1x220v**  
PRav-ar, SD

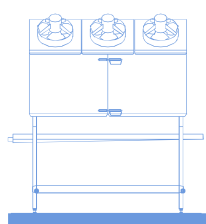
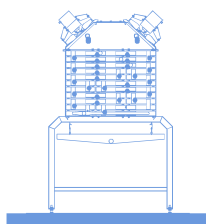

**SF6CH-16F-2C-2V3x380v**  
PRav, PXar, SD

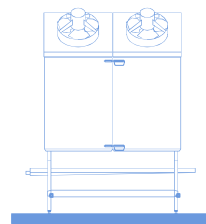
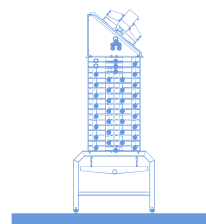

**SF3PL...**

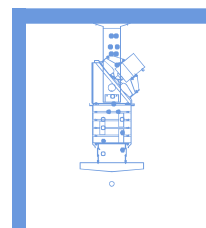

**DF3PL...**

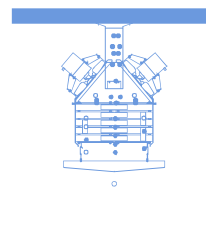

**DF4.5PL...**

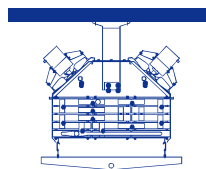

**SF3, DF3, DF4.5**  
1,2 or 3 fans per side

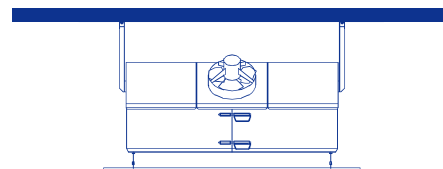

**SF6PL...**

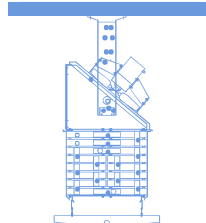

**SF6, DF6**  
1,2 or 3 fans per side

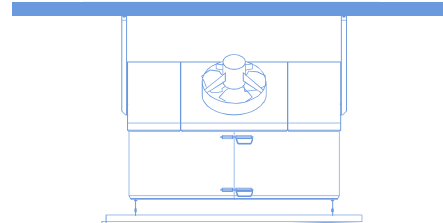

**DF6...SG**

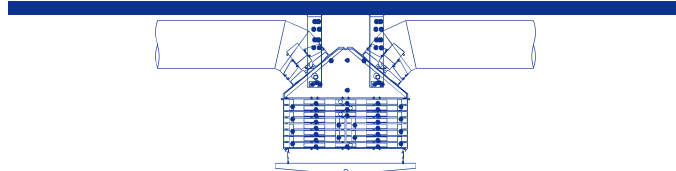

Other available options: textile ducts, humidification nozzles.



[www.climinox.com](http://www.climinox.com)

## CONTACT

[climinox@wanadoo.fr](mailto:climinox@wanadoo.fr)

PHONE: +332 33 62 29 50